

Part Number: PT936-03180-XX

Kit Contents

Item #	Quantity Req'd.	Description
1	1	Front Driver Door Guard (Reference Pink Sticker)
2	1	Front Passenger Door Guard (Reference Blue Sticker)
3	1	Rear Driver Door Guard (Reference Green Sticker)
4	1	Rear Passenger Door Guard (Reference Yellow Sticker)

Hardware Bag Contents

Item #	Quantity Req'd.	Description
1	N/A	

Additional Items Required For Installation

Item #	Quantity Req'd.	Description
1	A/R	DIO: Simple Green All-Purpose Cleaner – Full Strength PPO: VDC Approved Cleaner
2	A/R	Lint-free towels
3	A/R	Blue painter's masking tape
4	1	Scissors

Conflicts

None

Recommended Tools

Personal & Vehicle Protection	Notes
None	
Special Tools	Notes
PPO Magnetic Template	IADS p/n = CAM18-0001
Sealant Adjustment Tool	IADS p/n= HIG11-D5-04
DIO Paper Door Templates	See last pages of these instructions
Nylon Removal Tool(NRT)	SST p/n = 00002-06002-01
Installation Tools	Notes
12-oz. rubber mallet	IADS p/n =PRI10-D5-02 Vaughn, p/n = SF12
Special Chemicals	Notes
VDC approved cleaner up to 70% alcohol	

General Applicability

All Camry & Hybrid models

Recommended Sequence of Application

Item #	Accessory
1	
2	

*Mandatory

Vehicle Service Parts (may be required for reassembly)

Item #	Quantity Req'd.	Description
1		
2		
3		

Legend

 **STOP:** Damage to the vehicle may occur. Do not proceed until process has been complied with.

 **OPERATOR SAFETY:** Use caution to avoid risk of injury.

 **CAUTION:** A process that must be carefully observed in order to reduce the risk of damage to the accessory/vehicle and to ensure a quality installation.

 **TOOLS & EQUIPMENT:** Used in Figures calls out the specific tools and equipment recommended for this process.

 **REVISION MARK:** This mark highlights a change in installation with respect to previous issue.

 **SAFETY TORQUE:** This mark indicates that torque is related to safety.



Care must be taken when installing this accessory to ensure damage does not occur to the vehicle. The installation of this accessory should follow approved guidelines to ensure a quality installation.









These guidelines can be found in the "Accessory Installation Practices" document.

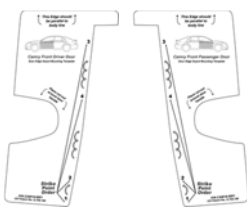
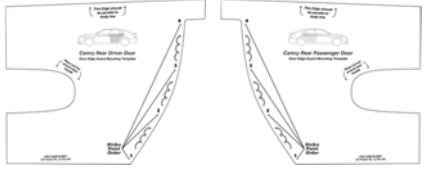

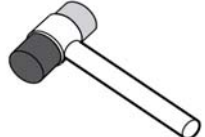

This document covers such items as:-

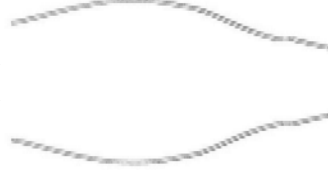

- Vehicle Protection (use of covers and blankets, cleaning chemicals, etc.).
- Safety (eye protection, rechecking torque procedure, etc.).
- Vehicle Disassembly/Reassembly (panel removal, part storage, etc.).
- Electrical Component Disassembly/Reassembly (battery disconnection, connector removal, etc.).

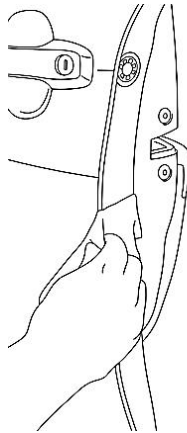
Vehicle Images shown below are generic and may not match actual vehicle.

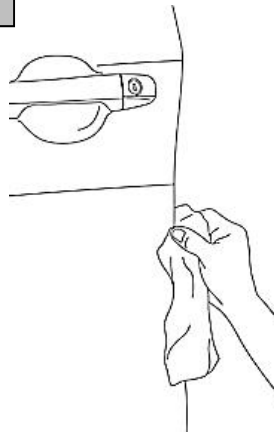
Please see your Toyota dealer for a copy of this document.

 <p>FRONT DOOR TEMPLATES</p>	 <p>REAR DOOR TEMPLATES</p>	 <p>CLEANER</p>	 <p>NYLON REMOVAL TOOL</p>	 <p>MALLET</p>
		 <p>TAPE</p>	 <p>SCISSORS</p>	 <p>LINT FREE</p>
 <p>FRONT DOOR EDGE GUARDS</p>	 <p>REAR DOOR EDGE GUARDS</p>	 <p>CHECK DOOR SEALANT BEFORE INSTALLATION. The sealant adjustment tool must be used if sealant is close to the door's edge. This must be done to allow for proper Door Edge Guard installation to verify sealant conditions.</p>		

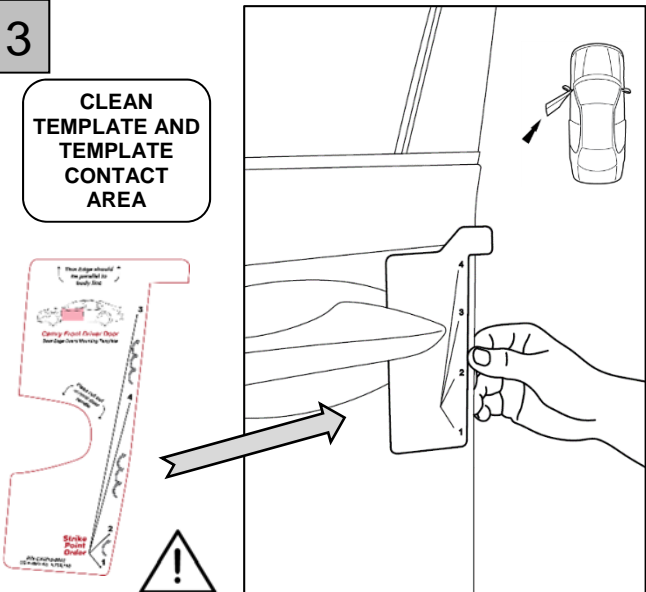
<p>1</p>  <p>ROTATE TOWEL AFTER EACH WIPE</p> <p>CLEAN ALL DOOR EDGES</p> <p>WIPE 4 TIMES</p> 	<p>2</p>  <p>ROTATE TOWEL AFTER EACH WIPE</p> <p>DRY ALL DOOR EDGES</p> <p>SQUEAK</p> 
---	--

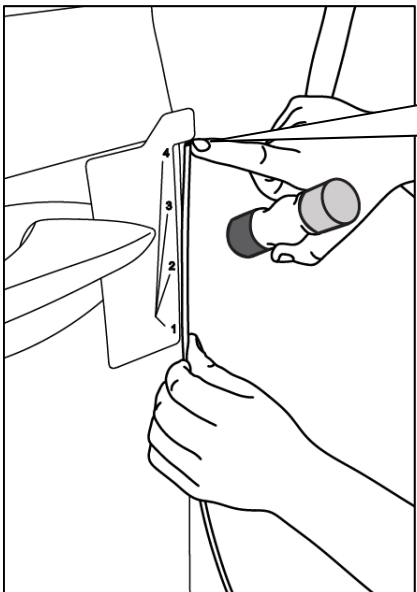
<p>3</p> <p>CLEAN TEMPLATE AND TEMPLATE CONTACT AREA</p>  	<p>4</p>  <p>ALIGN</p>
--	--

5

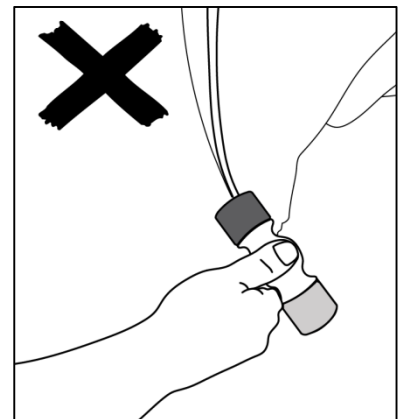
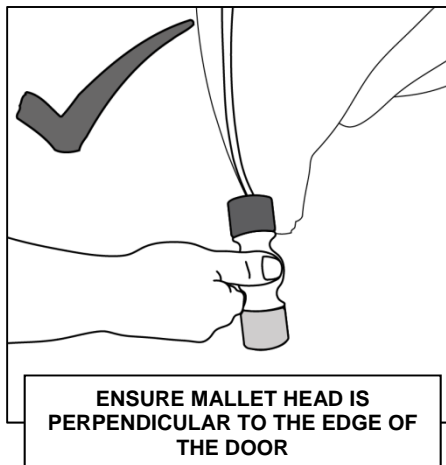
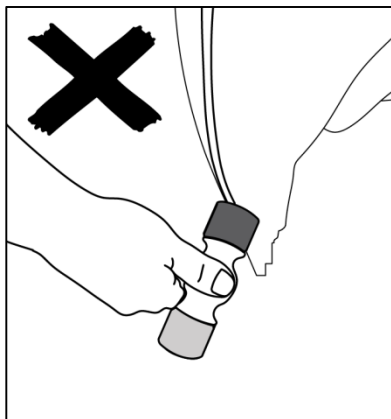
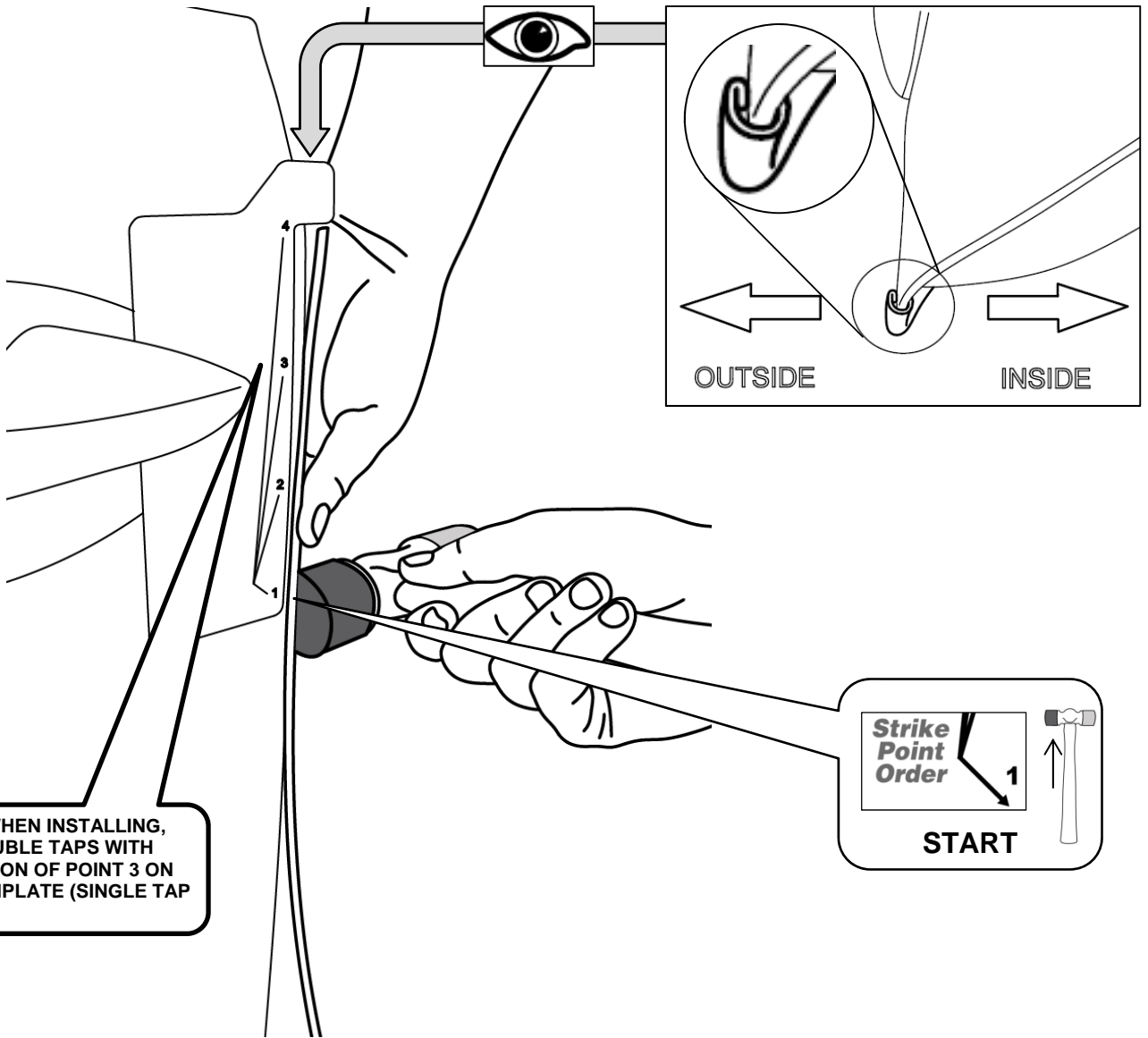

6

FRONT DOORS

ENSURE MALLET HEAD IS PERPENDICULAR TO THE EDGE OF THE DOOR

REAR DOORS

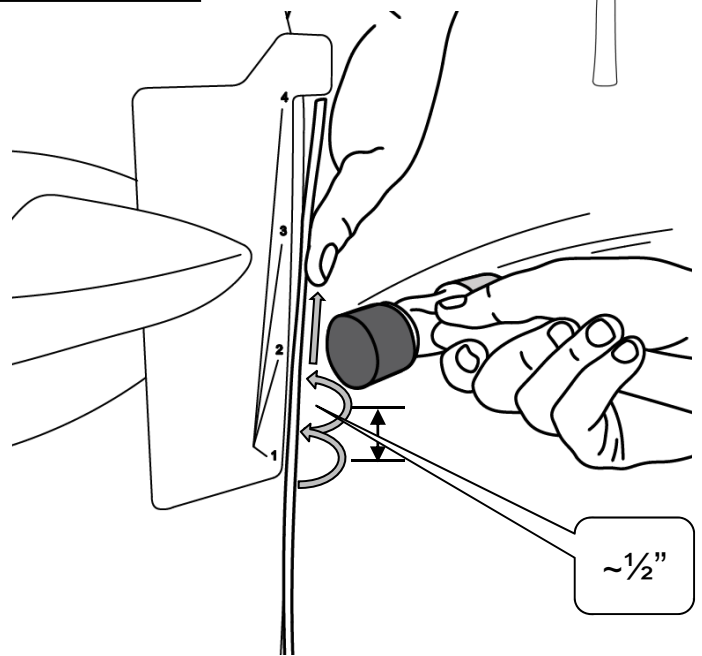
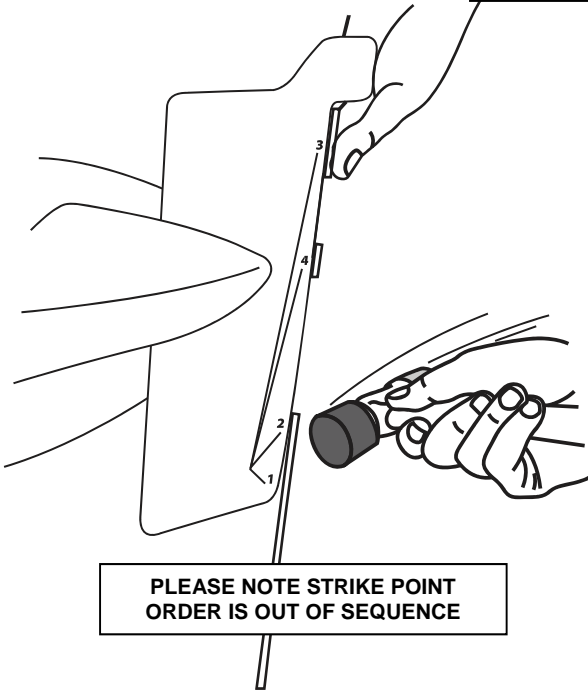
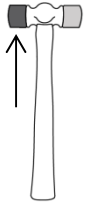

7

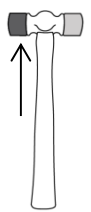
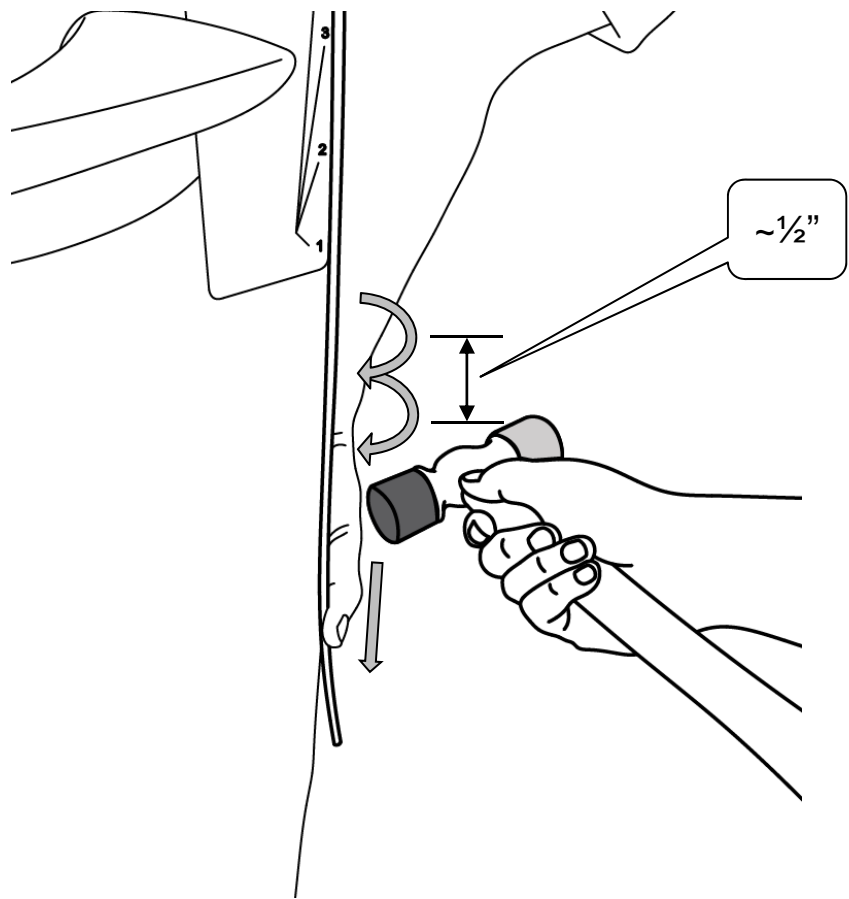

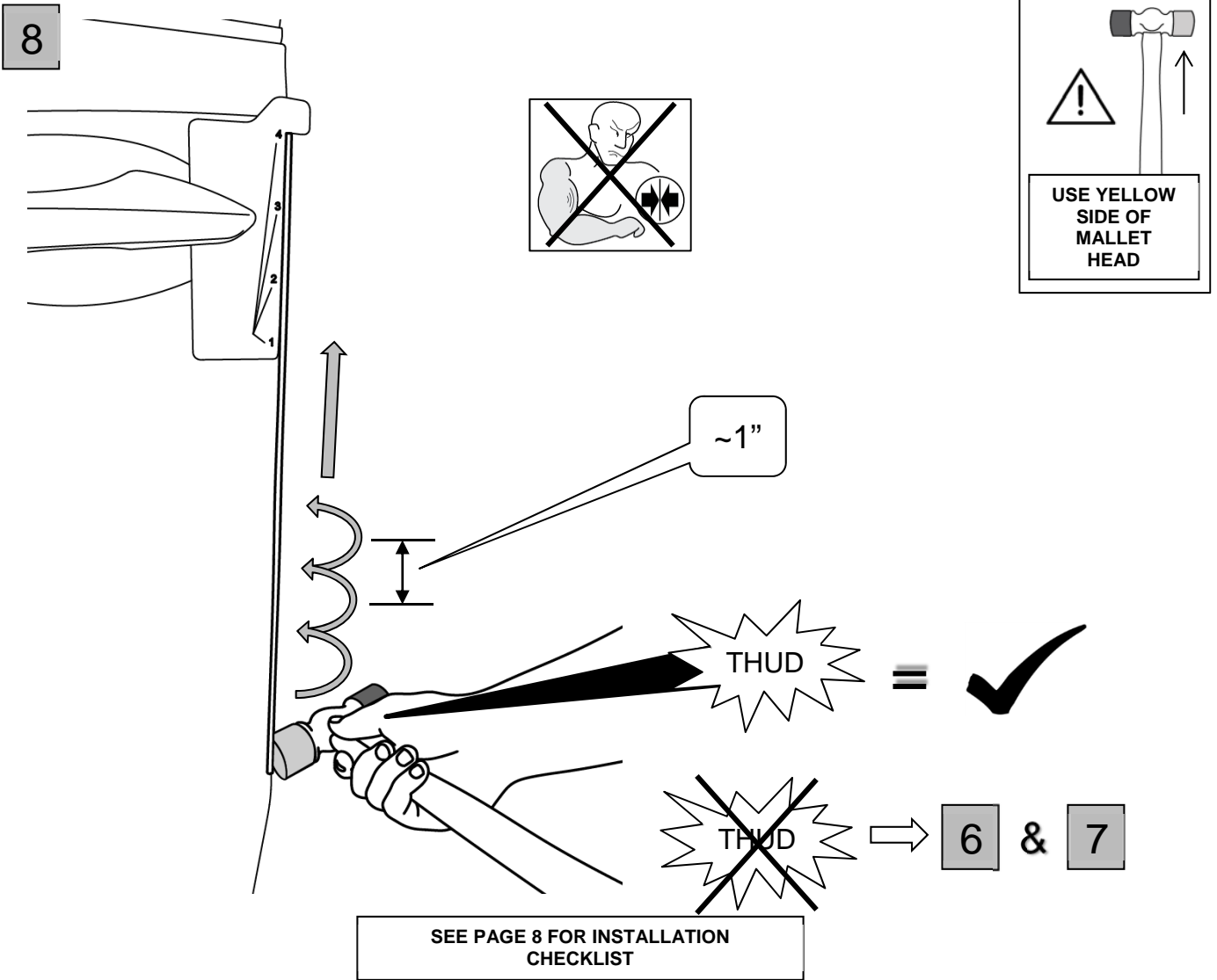

9 REPEAT ALL DOORS

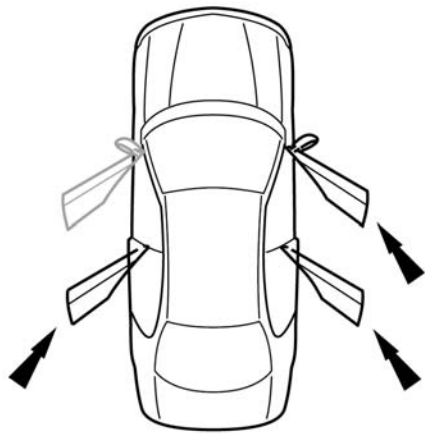

10

DEG REMOVAL

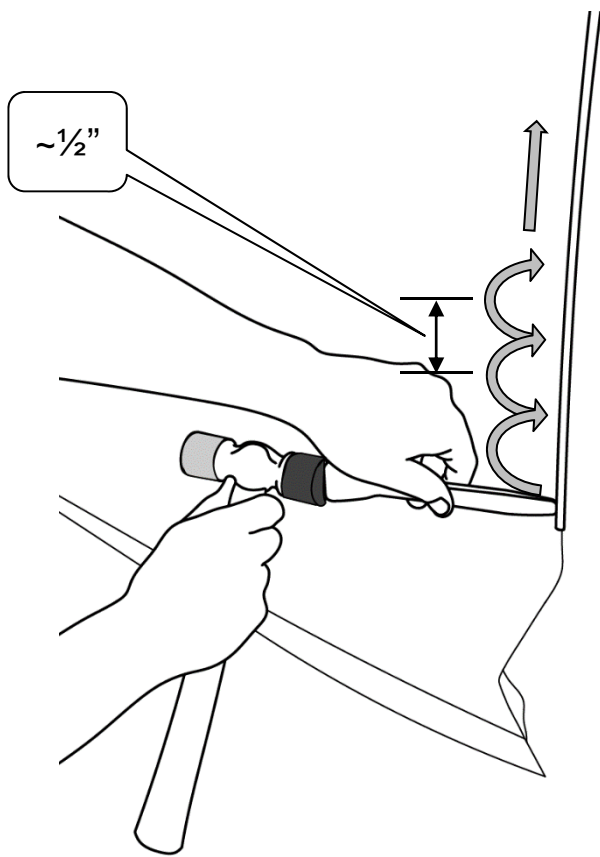
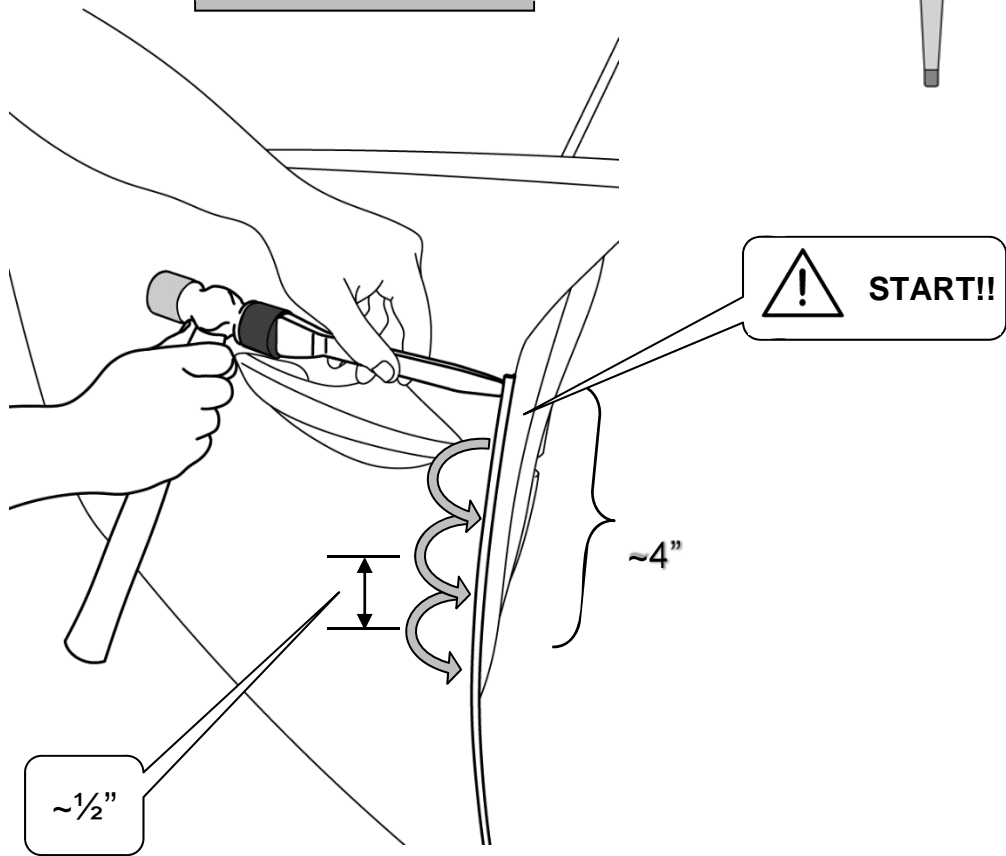
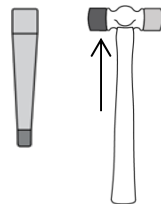

THIS PAGE PPO ONLY

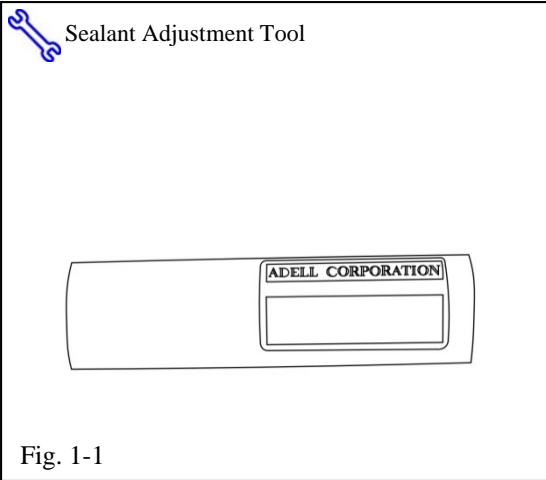

NOTE: Use the adjustment tool to verify if sealant is close to the door's edge. This must be done prior to **Door Edge Guard** installation to allow for proper fit (Fig. 1-1).

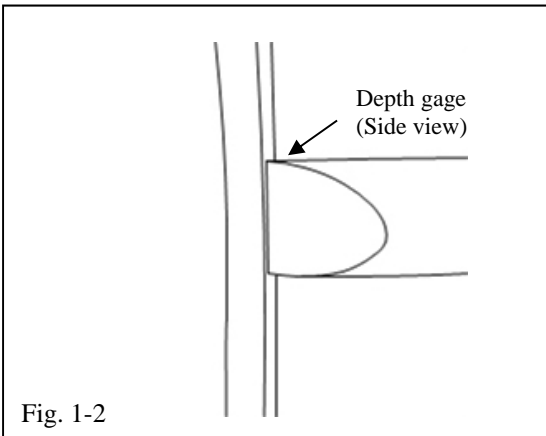

Align the adjustment tool to the edge of the door, with the angle edge positioned toward the inside of the door (Fig. 1-2).

Use the adjustment tool as a depth gage down the entire length of the door's edge. This is to verify that the sealant material is back away from the edge of the door to allow for proper Door Edge Guard installation.

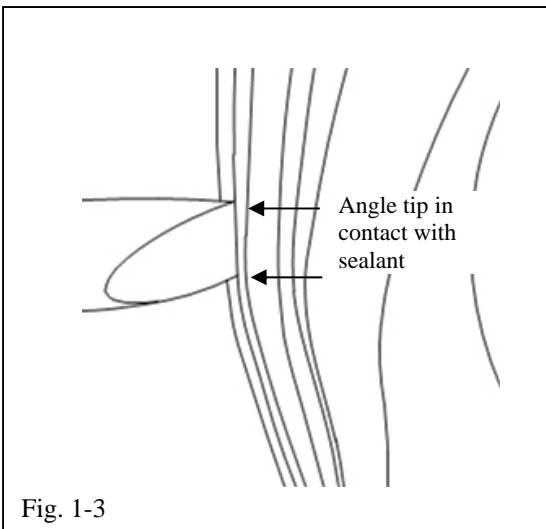

If the vehicle has a sealant issue: To push back sealant, align the adjustment tool to the edge of the door, with the angle edge positioned toward the inside of the door (Fig. 1-3).

With the adjustment tool angle tip in contact with the sealant material, push the adjustment tool inward so that the notched section of the tool is in complete contact with the door's edge. Continue down the door's edge or sections of the door's edge that requires adjustment.

Checklist - these points **MUST** be checked to ensure a quality installation.

Check:	Look For:
<p><u>Accessory Function Checks</u></p> <p><input type="checkbox"/> Confirm all Door Edge Guards are fully seated</p>	<p><u>Look For:</u></p> <p>Look for a fairly consistent gap between the DEG and adjoining vehicle panels.</p> <p>Gently use forefinger and thumb to pull Door Edge Guard to ensure it is properly seated. Please follow the top, middle and bottom sequencing to gently pull the Door Edge Guard.</p> <p>NOTE: Normal vehicle manufacturing tolerances may exist that are not a consequence of an improperly seated DEG installation.</p>
<p><u>Vehicle Function Checks</u></p> <p><input type="checkbox"/> Vehicle door operation</p>	<p>Confirm both doors open and close without interference from DEG or Body Side Molding (if installed).</p>
<p><u>Vehicle Appearance Check</u></p> <p><input type="checkbox"/> After accessory installation and removal of protective cover(s), perform a visual inspection.</p>	<p>Ensure no damage (including scuffs and scratches) was caused during the installation process.</p> <p>(For PPO installations, refer to TMS Accessory Quality Shipping Standard.)</p>

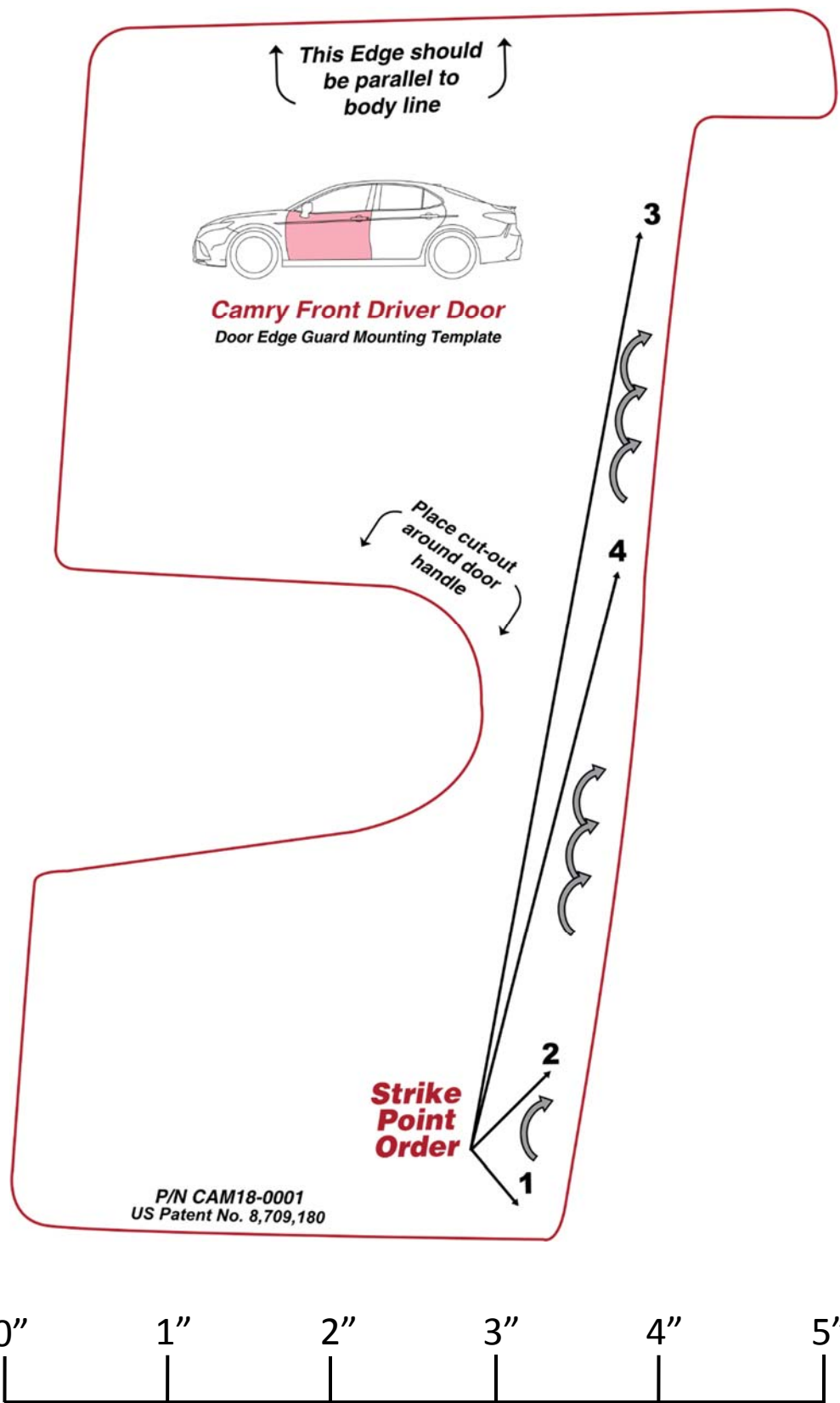

Dealer Installation Note: Check the above scale to ensure it is 1:1. Adjust on photocopier if it is not to scale. If this is a pdf document, set the "Page Scaling" to "None" in the Print dialogue box prior to printing.

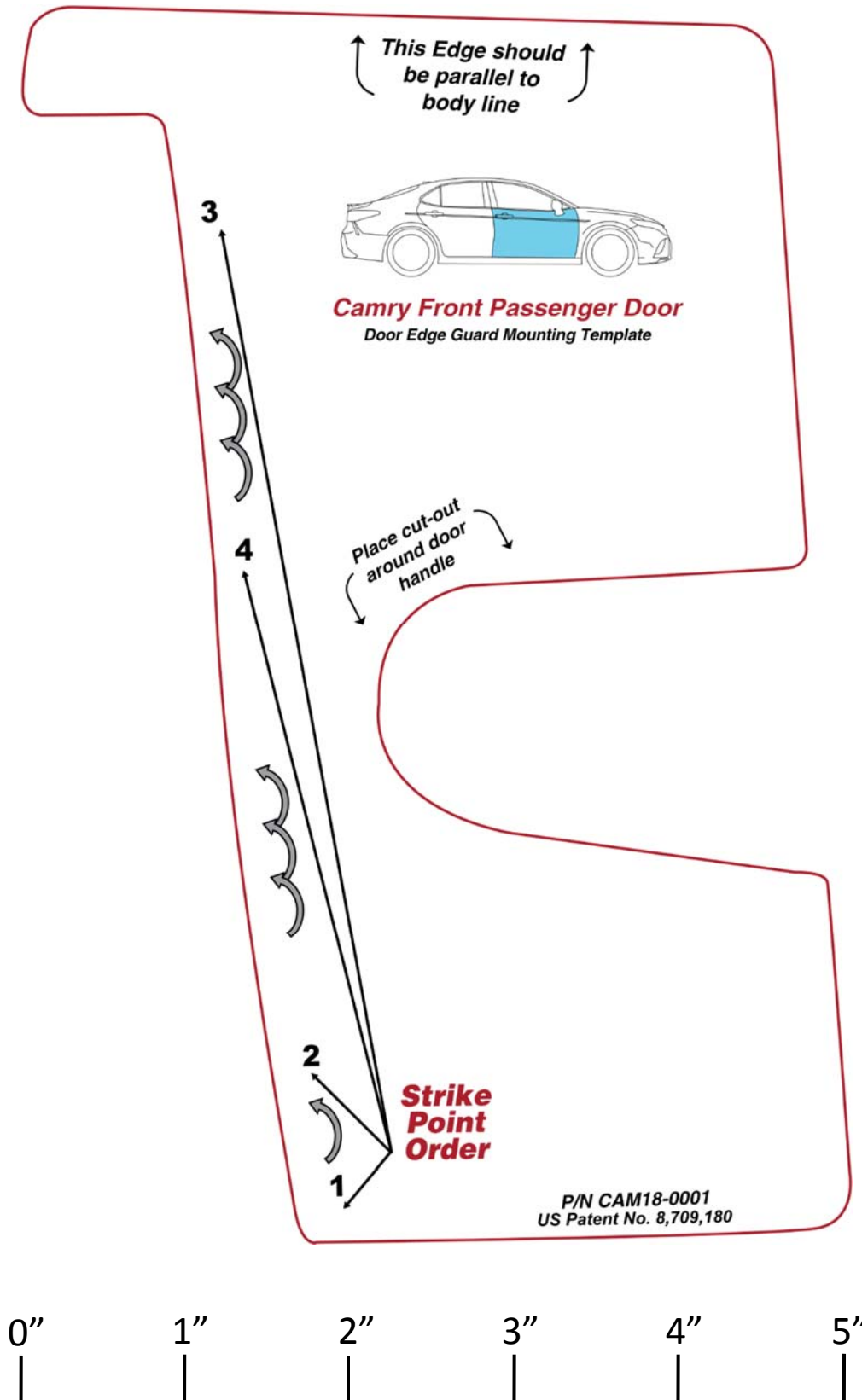

Dealer Installation Note: Check the above scale to ensure it is 1:1. Adjust on photocopier if it is not to scale. If this is a pdf document, set the "Page Scaling" to "None" in the Print dialogue box prior to printing.

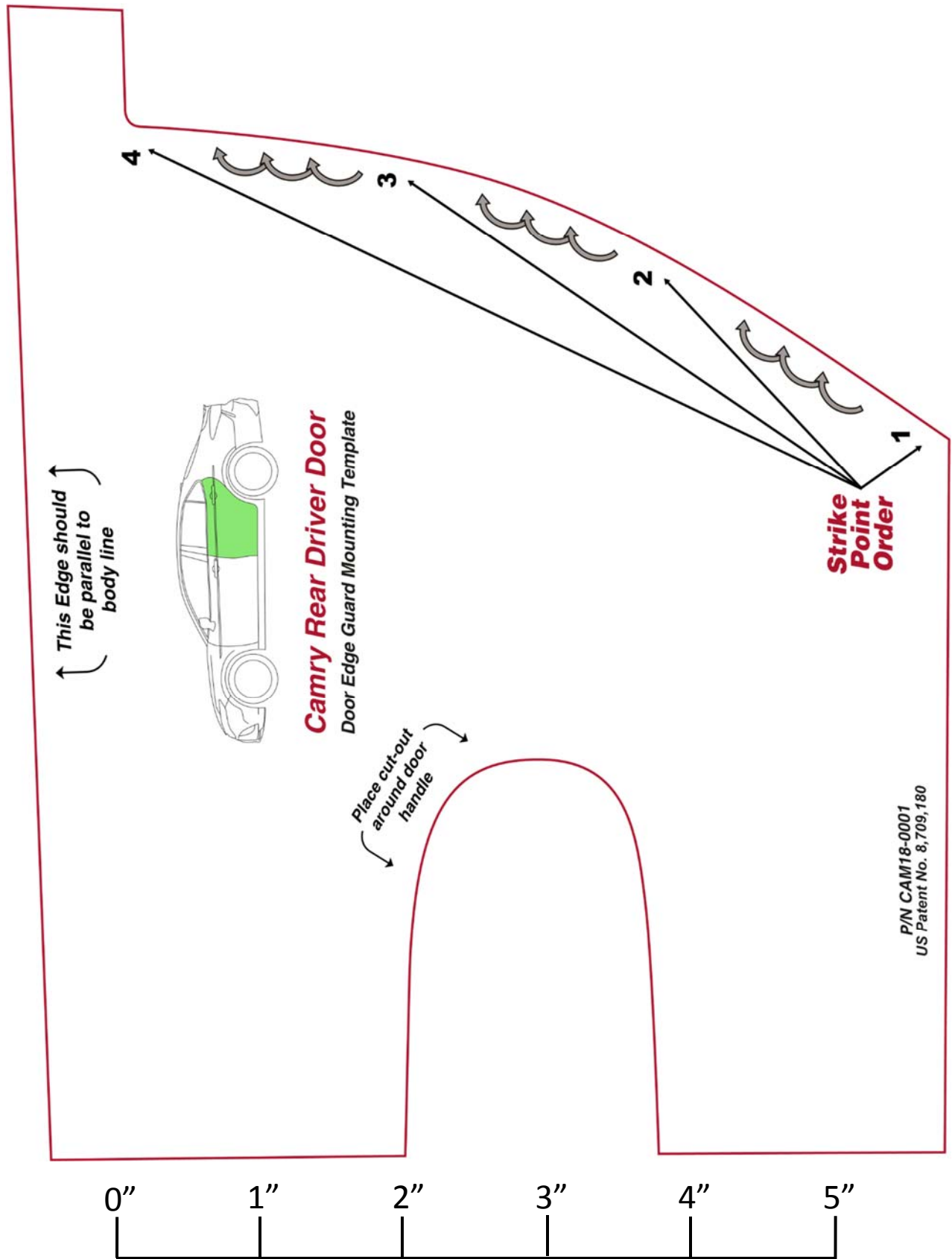

Dealer Installation Note: Check the above scale to ensure it is 1:1. Adjust on photocopier if it is not to scale. If this is a pdf document, set the "Page Scaling" to "None" in the Print dialogue box prior to printing.

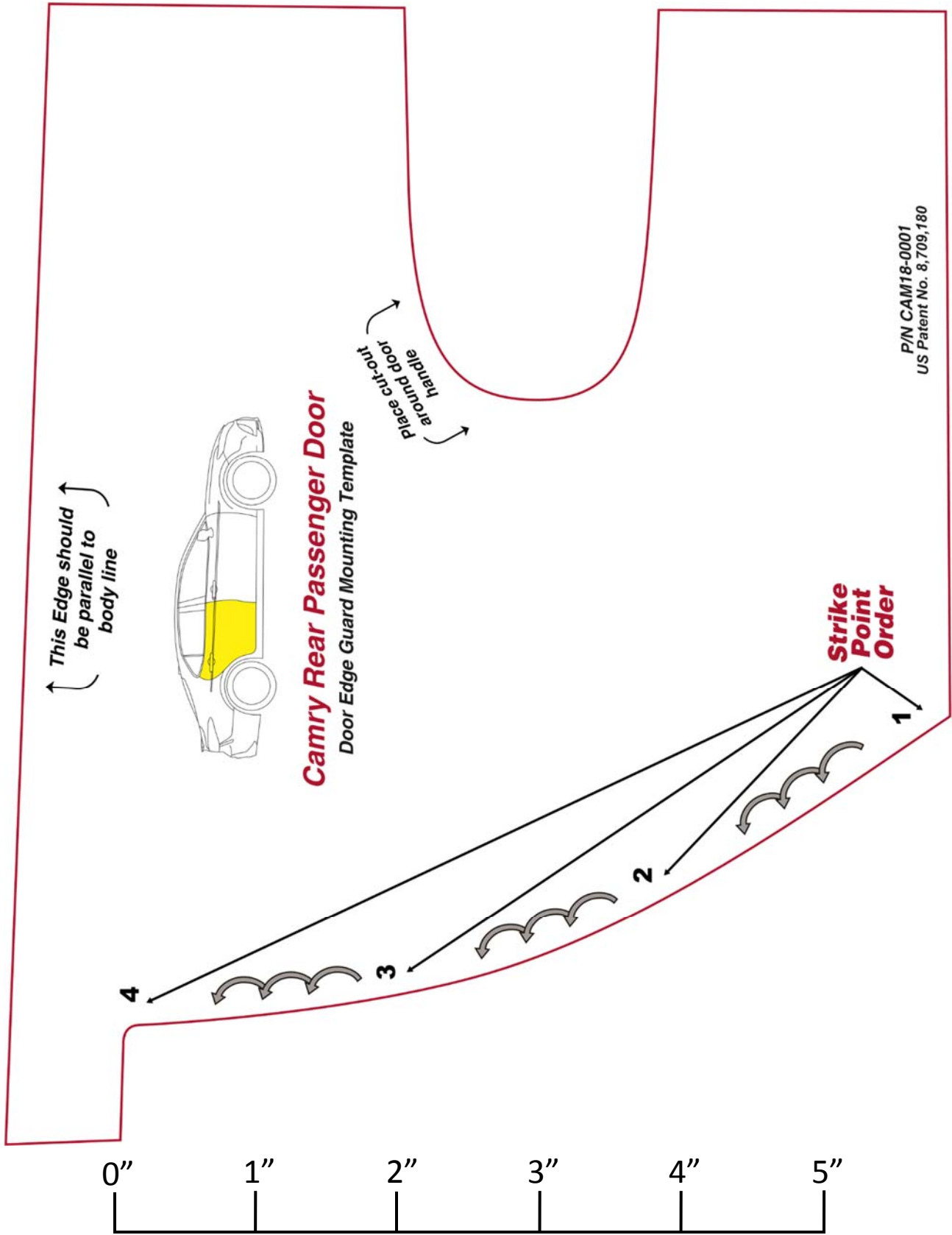

Dealer Installation Note: Check the above scale to ensure it is 1:1. Adjust on photocopier if it is not to scale. If this is a pdf document, set the "Page Scaling" to "None" in the Print dialogue box prior to printing.